

# Kształtki PE HD 80 i PE HD 100 do sieci wodociągowych i kanalizacji ciśnieniowej

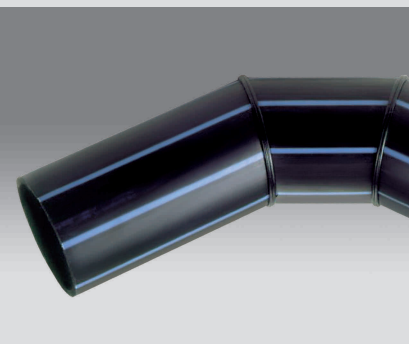
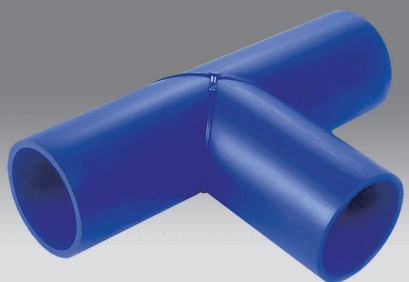

## Charakterystyka techniczna

Przedsiębiorstwo „Barbara Kaczmarek” produkuje:

- kształtki segmentowe z PE HD 80 i PE HD 100

Kształtki segmentowe z PE HD 80 i PE HD 100 przeznaczone są m.in. do budowy sieci wodociągowych, sieci kanalizacyjnych oraz do transportu płynów agresywnych

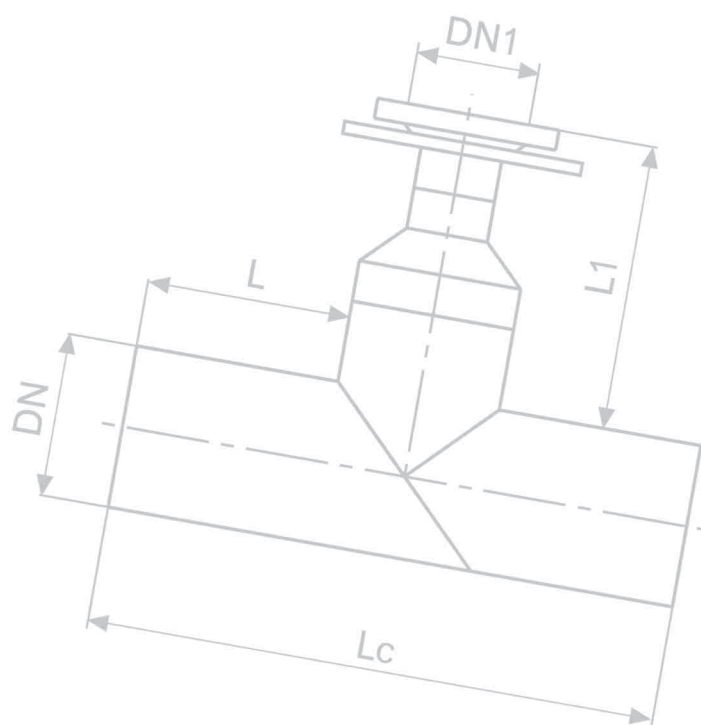

## Kształtki segmentowe do rur PE HD 100

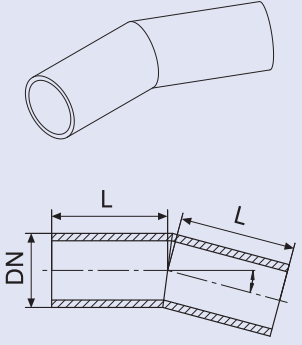
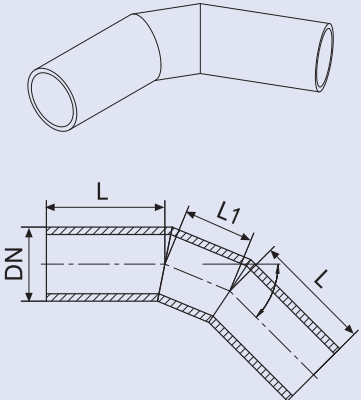
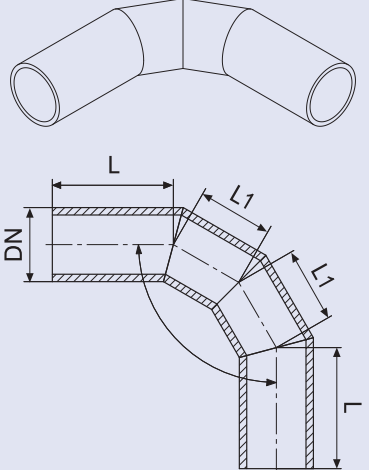
nazwa artykułu	DN [mm]	L [mm]	
<p><b>łuk segmentowy 15°, 30°</b></p> 	90	187	
	110	194	
	125	200	
	140	207	
	160	214	
	180	222	
	200	231	
	225	240	
	250	350	
	280	363	
	315	426	
	355	443	
	400	461	
	450	481	
<p><b>łuk segmentowy 45°, 60°</b></p> 	<p><b>DN [mm]</b></p>	<p><b>L [mm]</b></p>	<p><b>L1 [mm]</b></p>
	90	187	91
	110	194	95
	125	200	108
	140	207	122
	160	214	139
	180	222	155
	200	231	173
	225	240	194
	250	350	216
	280	363	242
	315	426	272
	355	443	307
	400	461	346
450	481	390	
<p><b>łuk segmentowy 90°</b></p> 	90	187	109
	110	194	117
	125	200	134
	140	207	151
	160	214	172
	180	222	193
	200	231	215
	225	240	241
	250	350	268
	280	363	300
	315	426	337
	355	443	380
	400	461	426
	450	481	483

## Kształtki segmentowe do rur PE HD 100

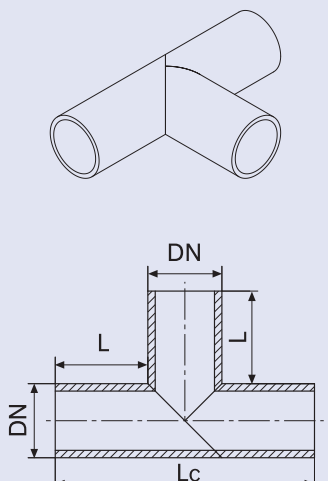
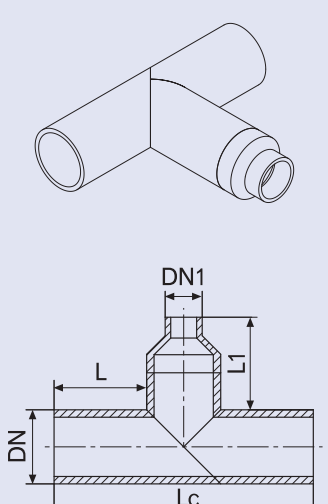
nazwa artykułu	DN [mm]	L [mm]	Lc [mm]		
<b>trójnik równoprzelotowy 90°</b> 	90	175	440		
	110	179	468		
	125	183	491		
	140	188	516		
	160	193	546		
	180	198	576		
	200	204	608		
	225	210	645		
	250	317	884		
	280	325	930		
	315	384	1083		
	355	395	1145		
	400	407	1214		
	450	421	1292		
<b>trójnik redukcyjny 90°</b> 	DN [mm]	DN1 [mm]	L [mm]	L1 [mm]	Lc [mm]
	90	63	175	320	440
	110	63	179	350	468
	110	90	179	350	468
	160	63	193	360	546
	160	90	193	360	546
	160	110	193	360	546
	200	63	204	360	608
	200	90	204	360	608
	200	110	204	360	608
	200	160	204	360	608
	225	90	210	370	645
	225	110	210	370	645
	225	160	210	370	645
	250	63	317	370	884
	250	90	317	370	884
	250	110	317	370	884
	250	160	317	370	884
	250	225	317	370	884
	315	63	384	370	1083
	315	90	384	370	1083
	315	110	384	370	1083
	315	160	384	370	1083
	315	225	384	370	1083
400	90	407	370	1214	
400	110	407	370	1214	
400	160	407	370	1214	
400	225	407	370	1214	
400	315	407	370	1214	

## Kształtki segmentowe do rur PE HD 100

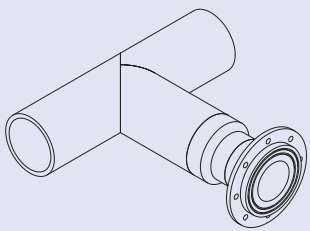
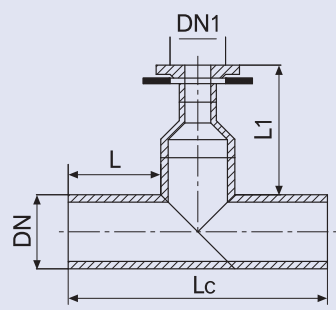
nazwa artykułu	DN [mm]	DN1 [mm]	L [mm]	L1 [mm]	Lc [mm]
<b>trójnik redukcyjny kołnierzowy 90°</b>    	90	50	175	404	440
	90	80	175	404	440
	110	50	179	434	468
	110	80	179	434	468
	110	100	179	434	468
	160	50	193	465	546
	160	80	193	465	546
	160	100	193	465	546
	160	150	193	465	546
	200	50	204	465	608
	200	80	204	465	608
	200	100	204	465	608
	200	150	204	465	608
	225	50	210	485	645
	225	80	210	485	645
	225	100	210	485	645
	225	150	210	485	645
	225	200	210	485	645
	250	50	317	475	884
	250	80	317	475	884
	250	100	317	475	884
	250	150	317	475	884
	250	200	317	475	884
	315	50	384	460	1083
	315	80	384	460	1083
	315	100	384	460	1083
	315	150	384	460	1083
	315	200	384	460	1083
	315	300	384	460	1083
	400	80	407	510	1214
	400	100	407	510	1214
	400	150	407	510	1214
400	200	407	510	1214	
400	300	407	510	1214	
400	400	407	510	1214	

## Kształtki segmentowe do rur PE HD 100

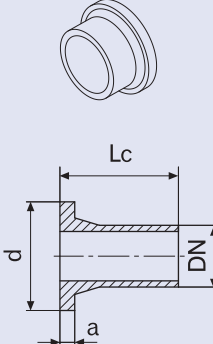
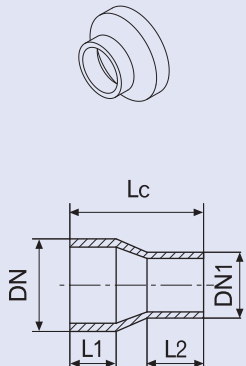
nazwa artykułu	DN [mm]	d [mm]	a [mm]	Lc [mm]	
<b>tuleja kołnierzowa</b>  	50	88	12	96	
	63	102	14	105	
	75	122	16	120	
	90	138	17	120	
	110	158	18	130	
	125	158	25	115	
	140	188	25	115	
	160	212	25	145	
	180	212	30	120	
	200	268	32	130	
	225	268	32	135	
	250	320	35	155	
	280	320	35	155	
	315	370	35	155	
	355	430	40	120	
	400	482	46	140	
450	585	60	150		
<b>redukcja centryczna</b>  	<b>DN [mm]</b>	<b>DN1 [mm]</b>	<b>Lc [mm]</b>	<b>L1 [mm]</b>	<b>L2 [mm]</b>
	90	63	130	45	55
	90	75	130	45	70
	110	63	140	50	55
	110	90	145	60	65
	125	63	120	40	40
	125	75	120	40	50
	125	90	120	40	50
	160	63	130	50	45
	160	90	130	45	45
	160	110	150	60	60
	160	125	135	50	50
	180	160	120	50	40
	200	160	120	50	40
	225	160	135	60	55
	225	200	105	40	40
	250	160	150	40	65
	250	225	105	40	40
	315	225	150	70	50
	315	250	150	70	50
355	315	90	30	30	
400	315	132	36	22	
400	355	84	36	24	
450	315	170	34	22	
450	355	130	34	24	
450	400	82	34	24	



## Normy, aprobaty, atesty

- PN-EN 12201-3:2004  
Systemy przewodów rurowych z tworzyw sztucznych do przesyłania wody, Polietylen (PE). Kształtki
- PN-EN 13244-3:2004  
Systemy przewodów rurowych z tworzyw sztucznych do ciśnieniowych rurociągów do wody użytkowej i kanalizacji deszczowej oraz sanitarnej, układane pod ziemią i nad ziemią, Polietylen (PE). Kształtki
- Atest Higieniczny HK/W/0896/01/2003 wydany przez Państwowy Zakład Higieny  
Rury polietylenowe oraz kształtki zgrzewcze.

